

slit substrate mount (34mm)

54 mm (2.125")
square

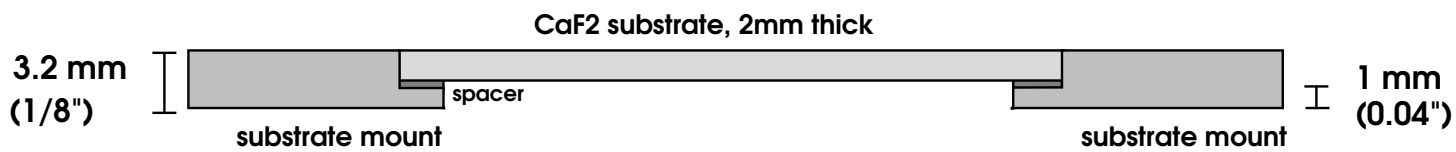
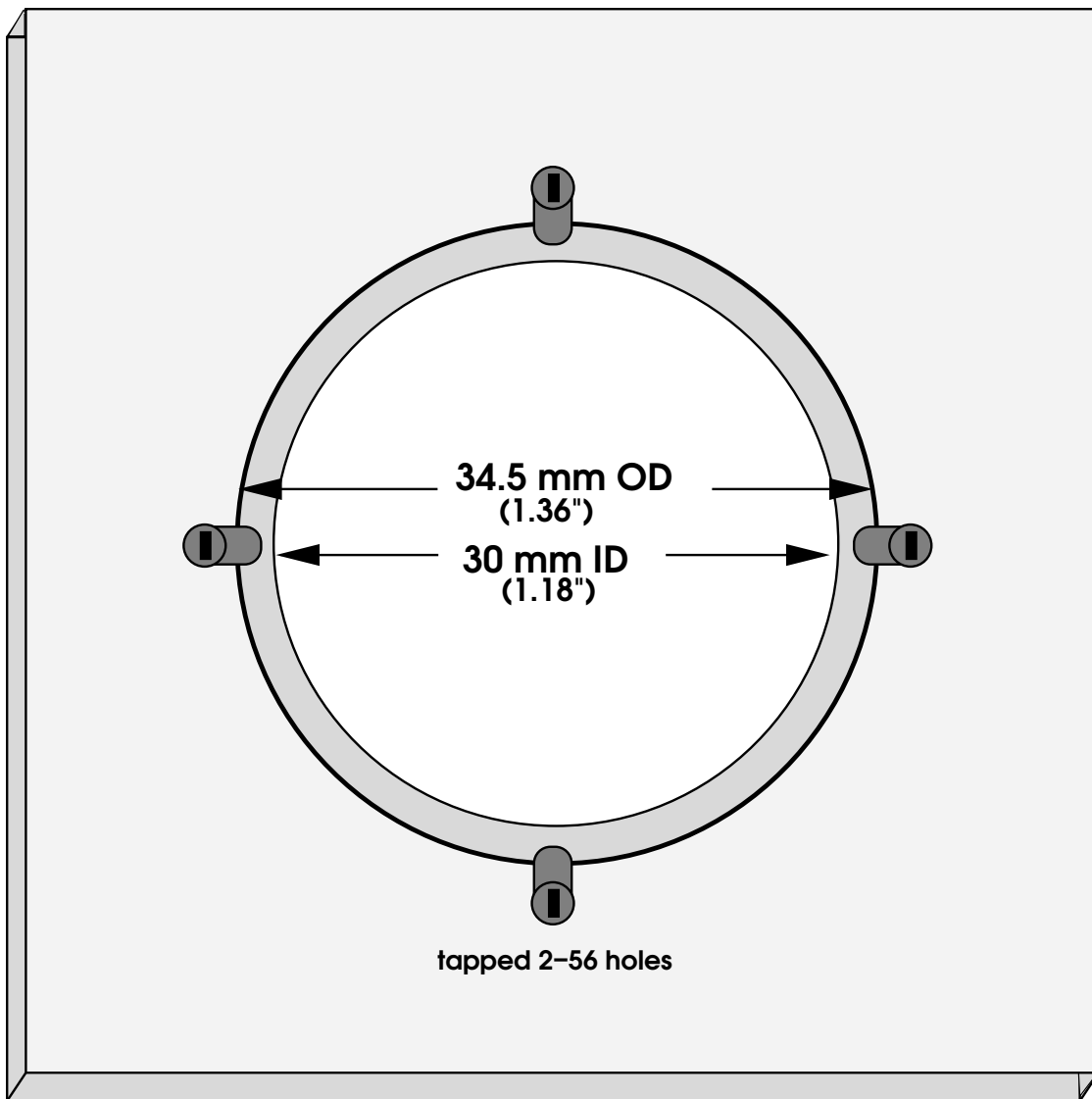

cross section (side view)